

Future experiments with cooled, optically pumped, radioactive ion beams

Paul Campbell

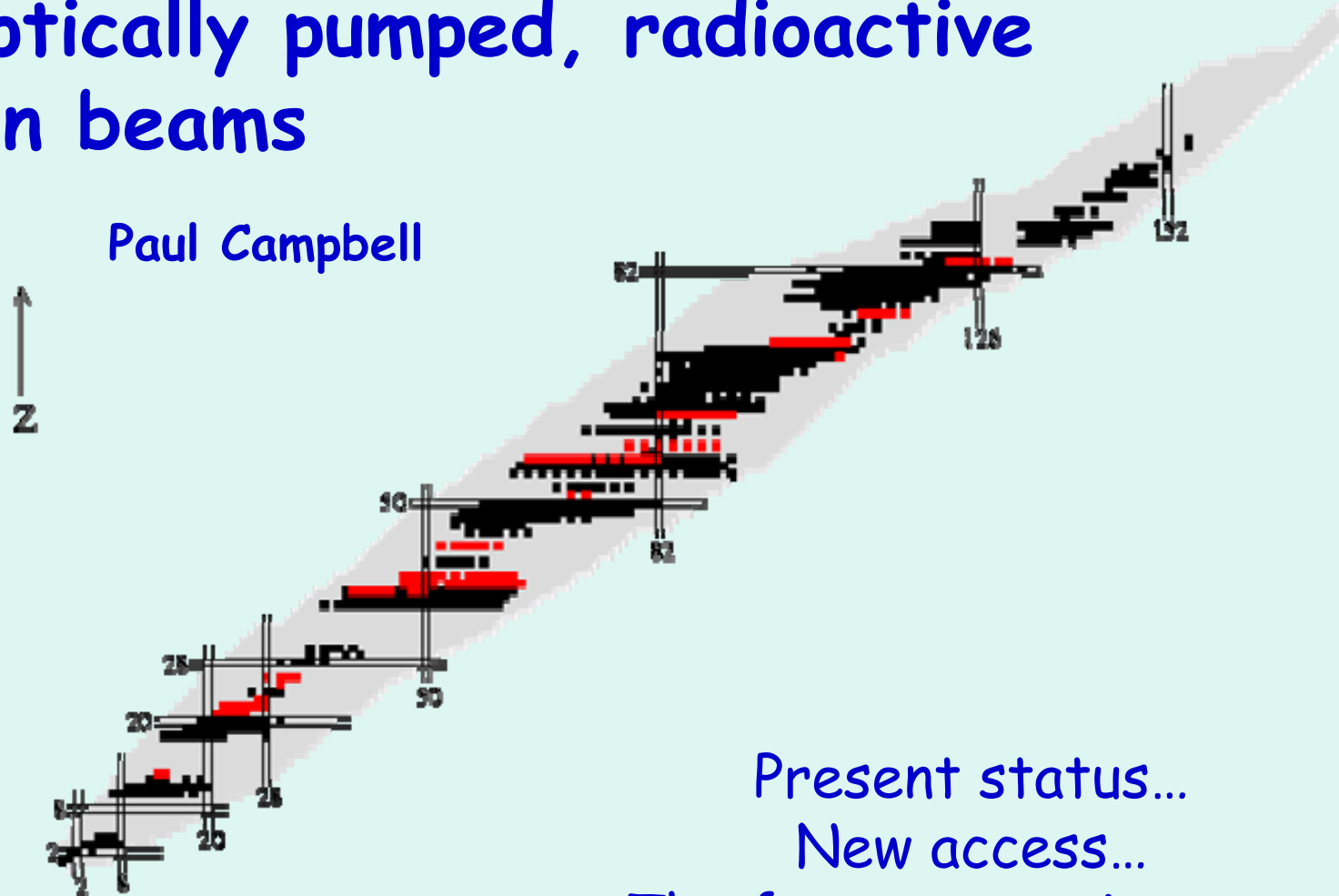

Present status...
New access...
The future experiments...

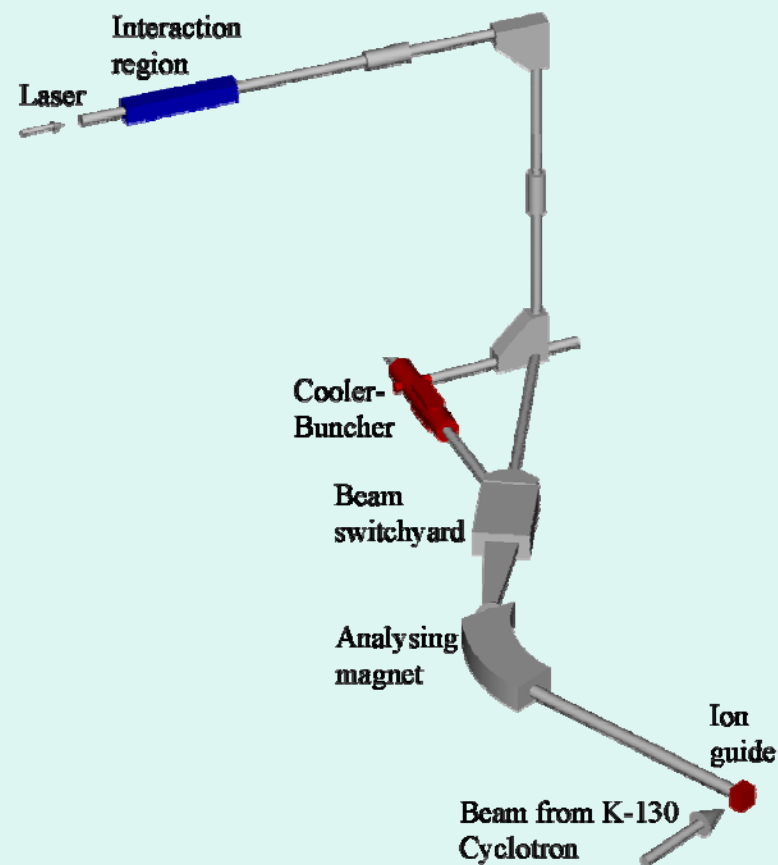
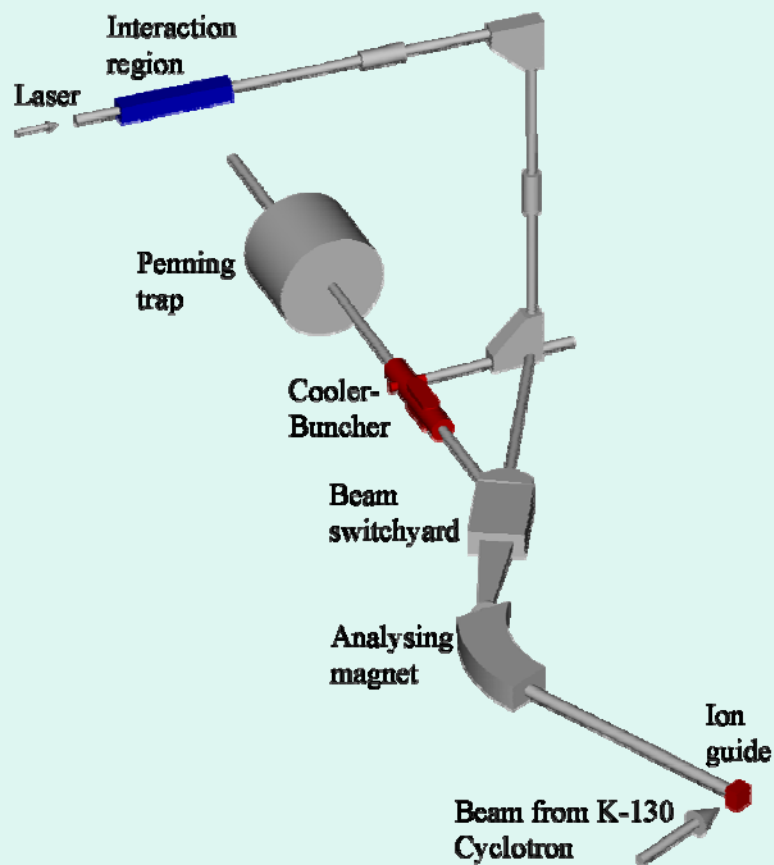

Pumping in the cooler:

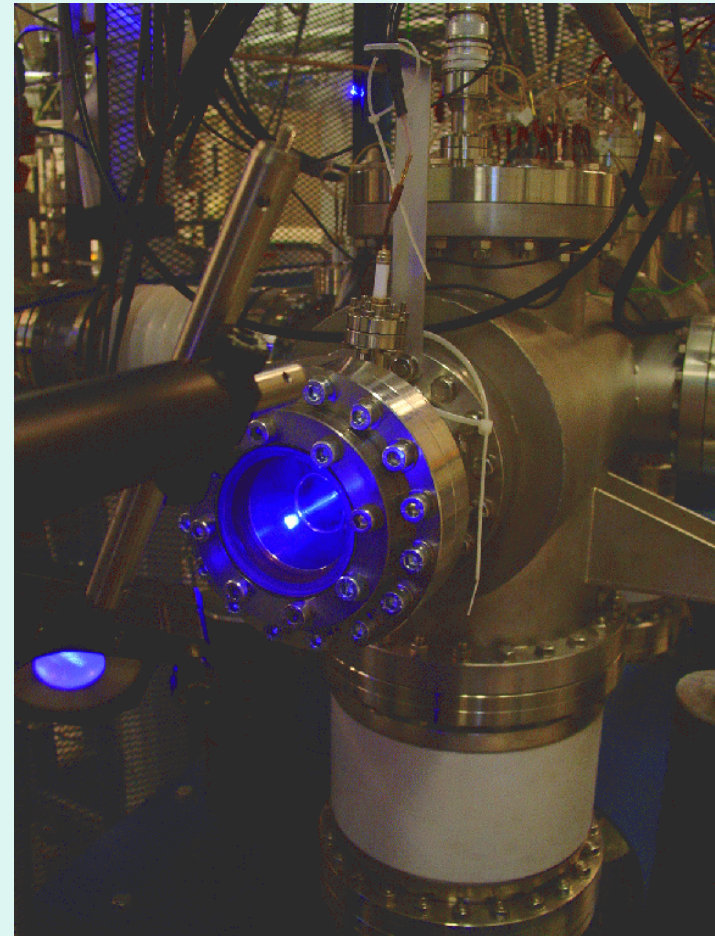
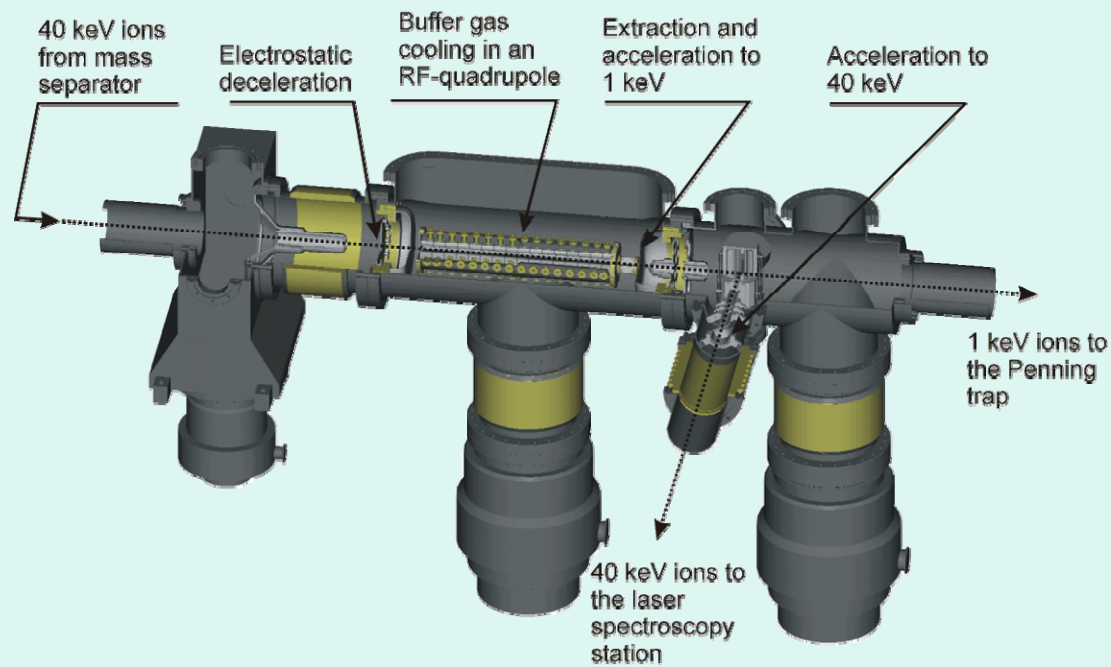

Pumping in the cooler: (Mn, Y, Y²⁺, Nb, Ta)

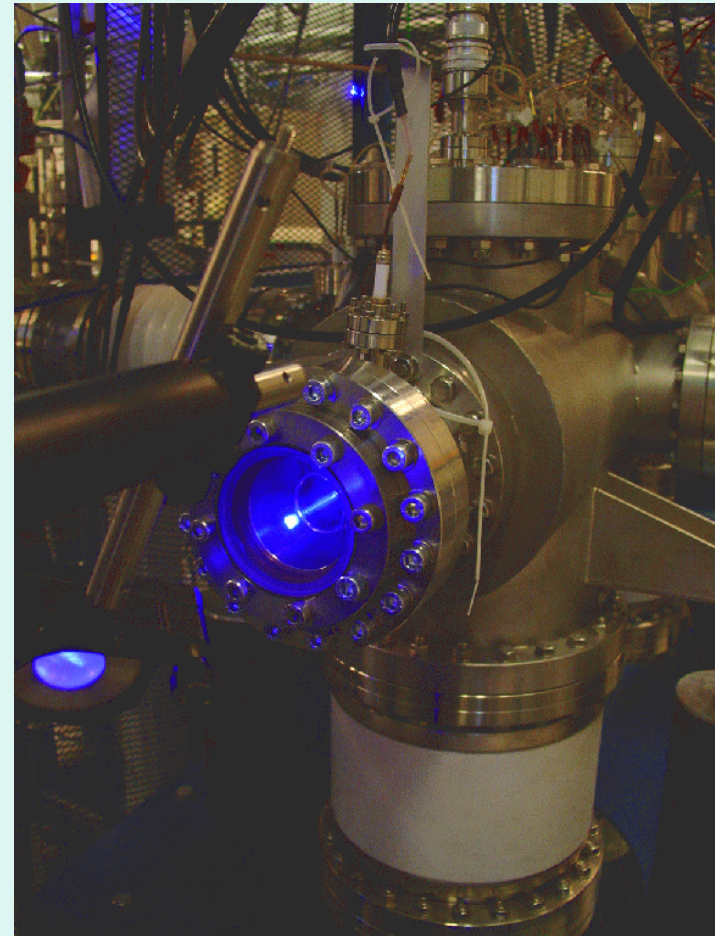
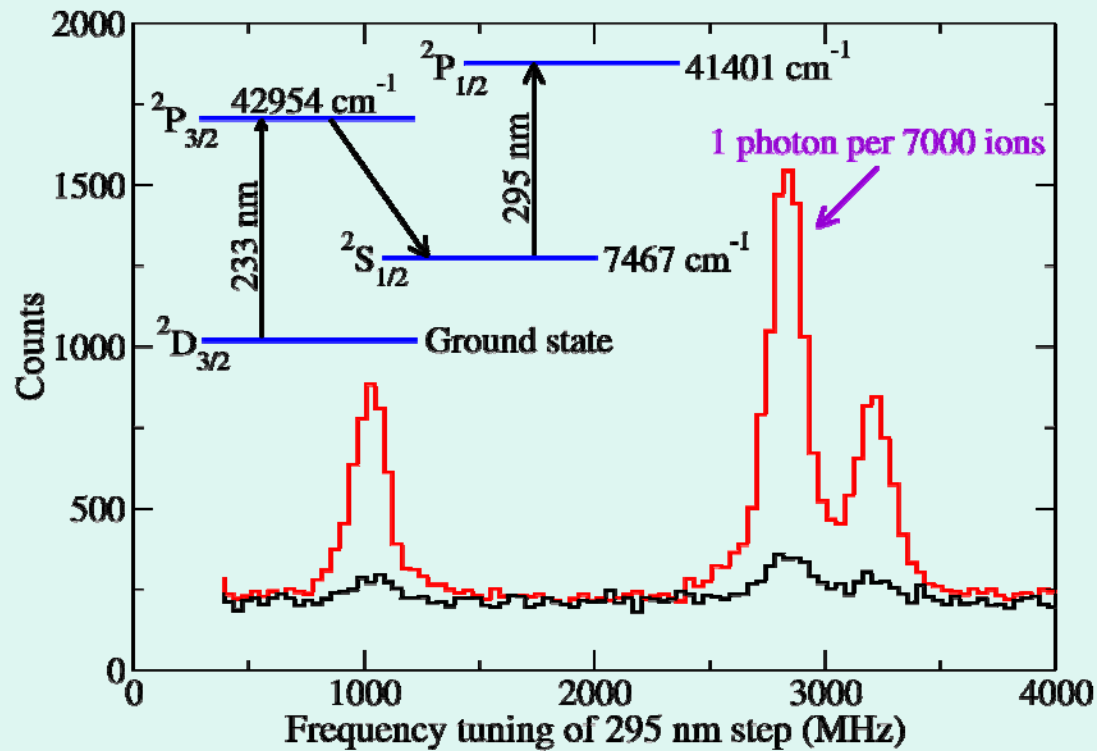

Pumping in the cooler: γ^{2+}

deep UV

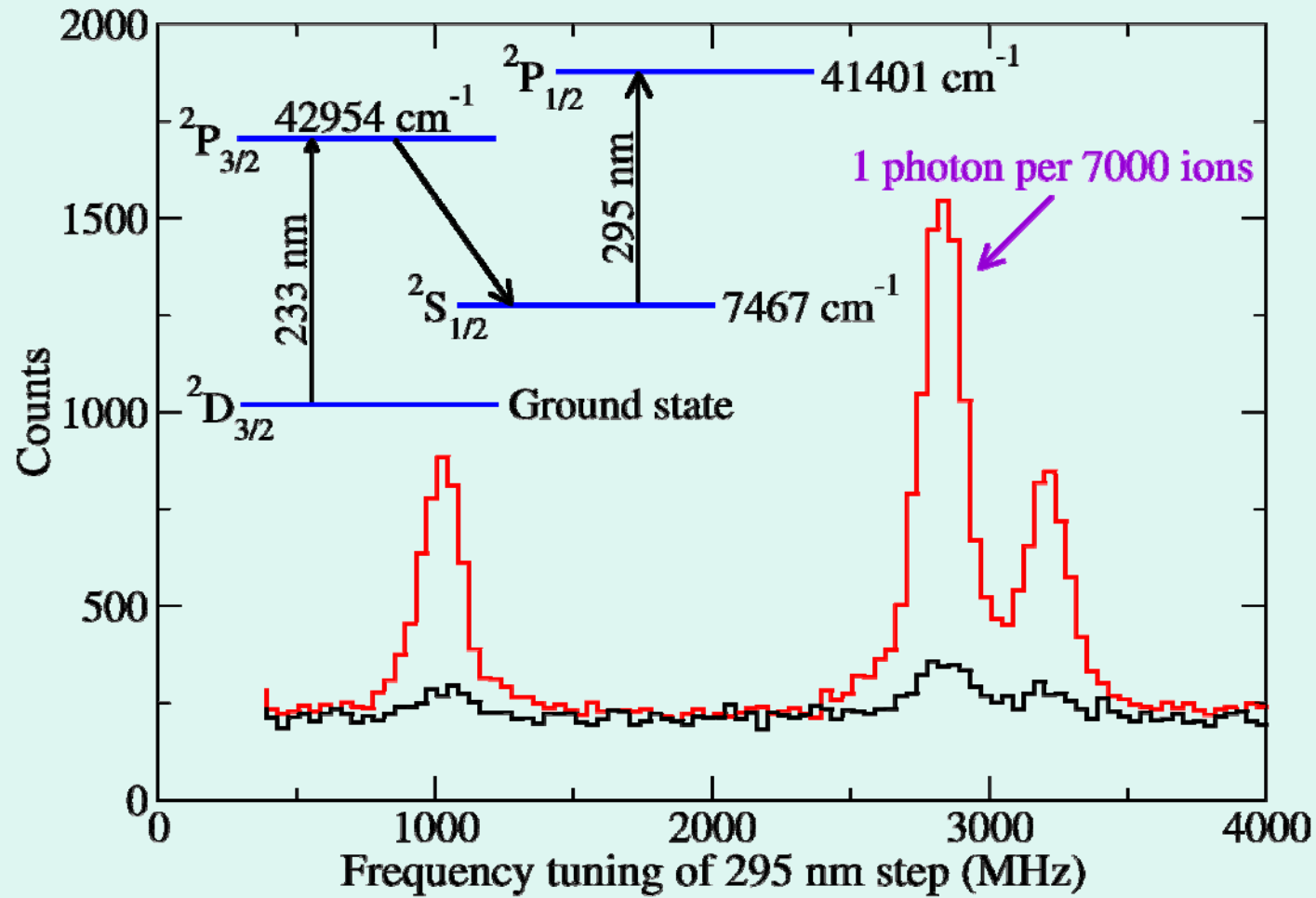

Niobium (cw)

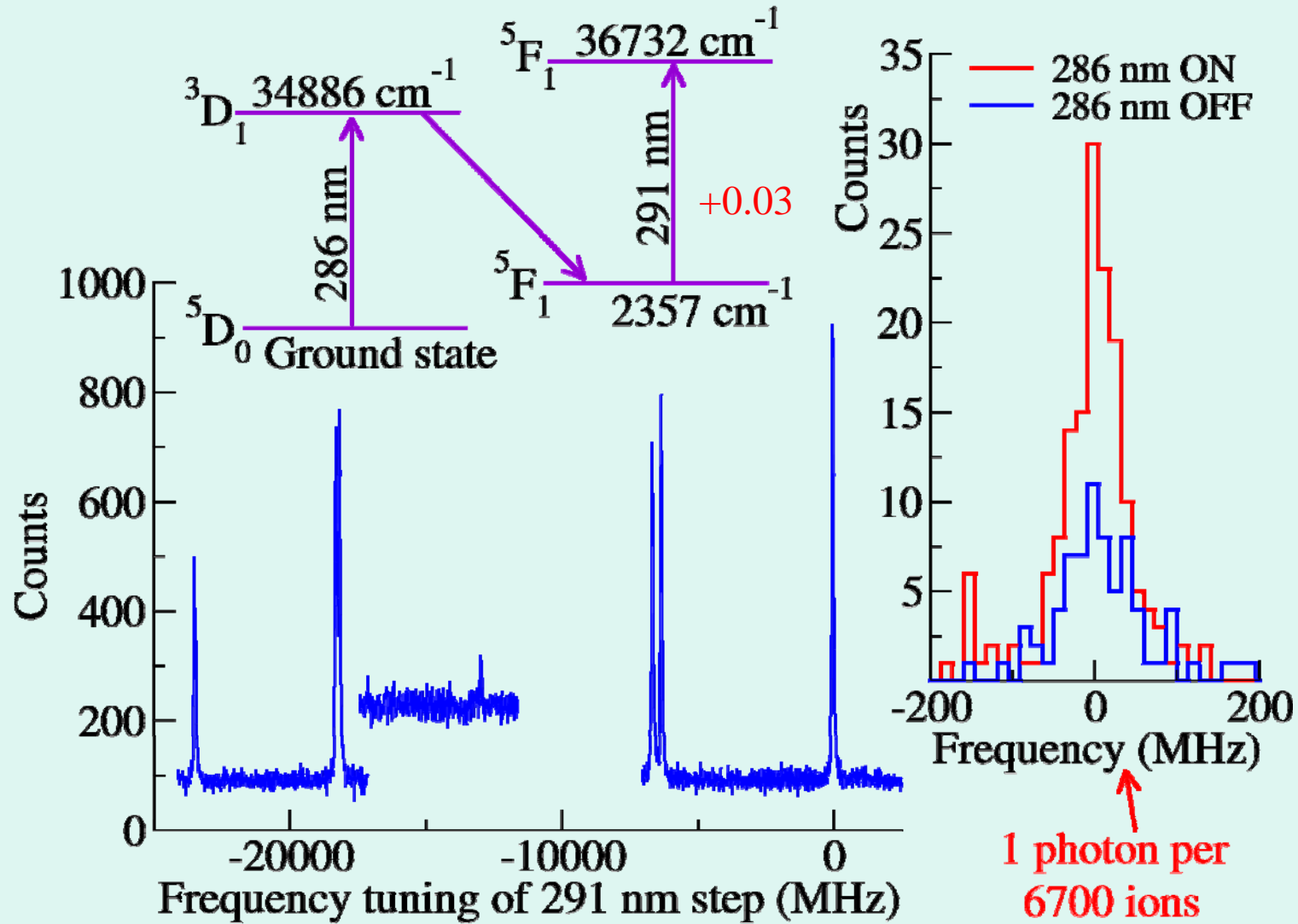

Niobium (on-line)

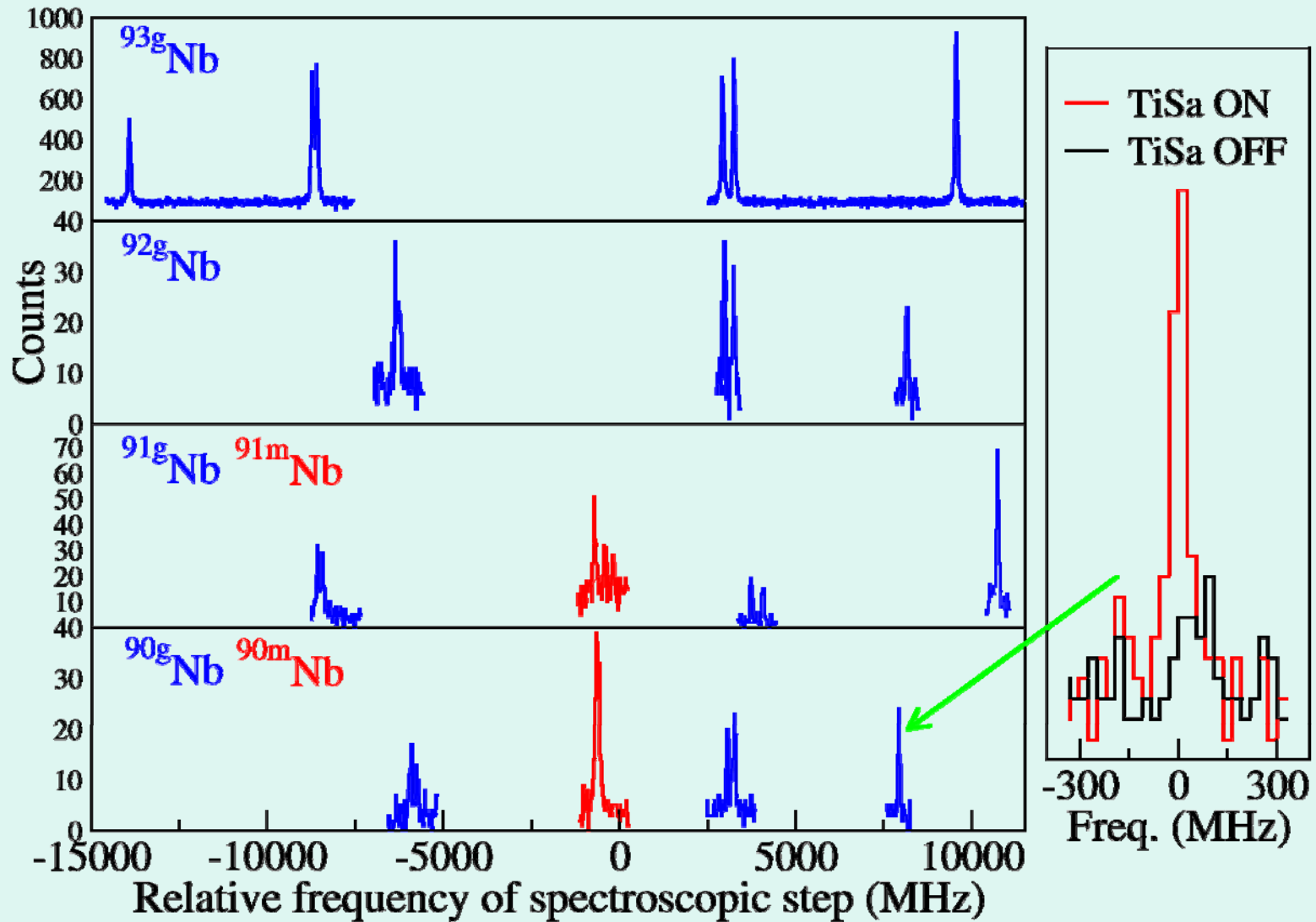

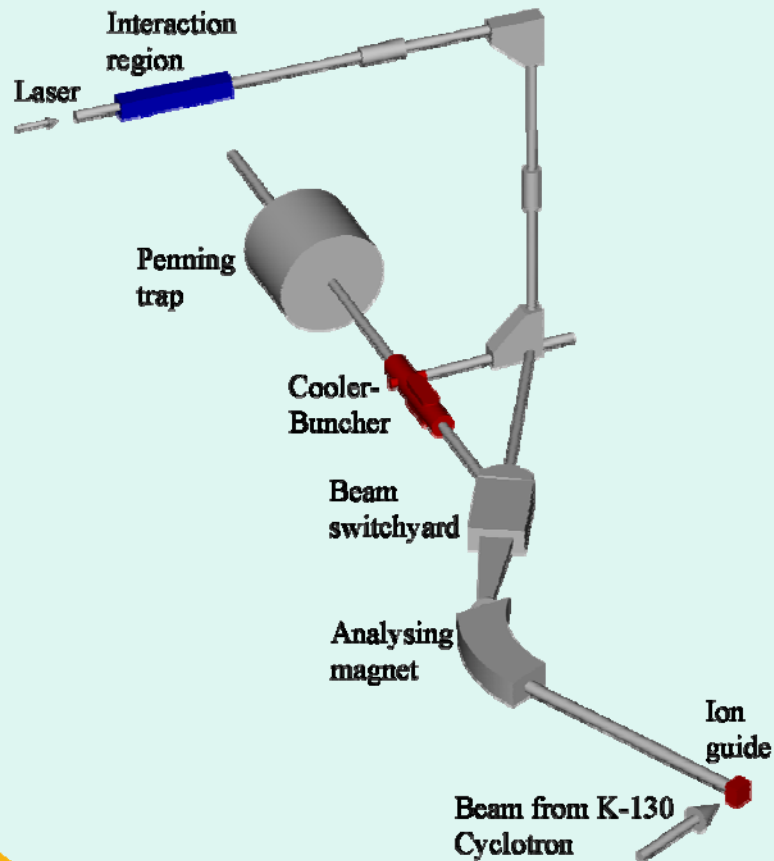

Reconstructing

i.e. get it the way
it should be..

(Frances' talk)

Pumping in the cooler: (Cr, Mo, Ru, Rh, W, etc??)

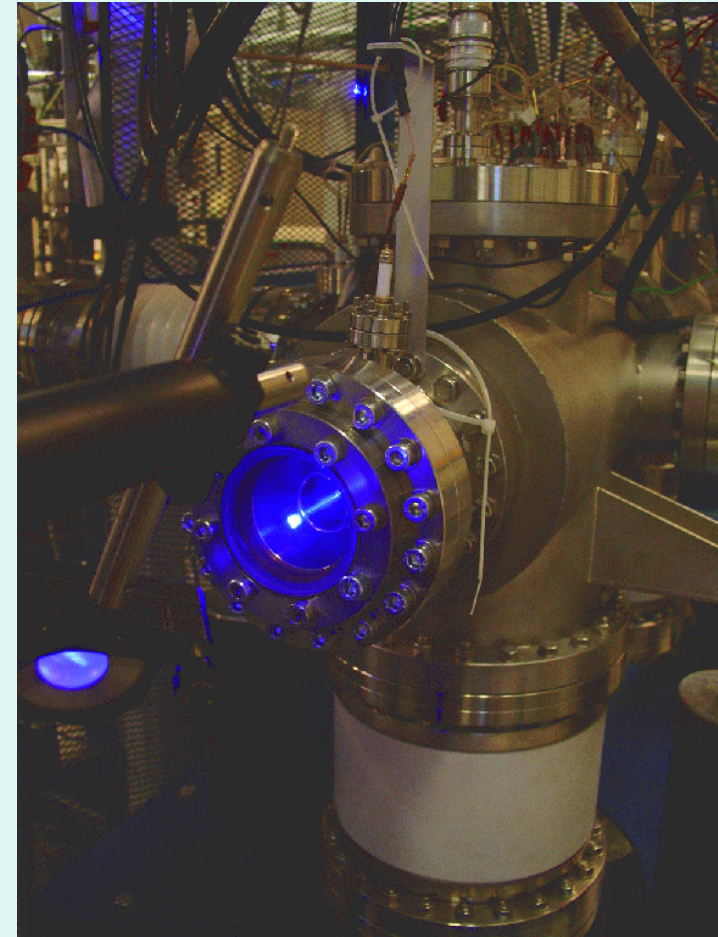
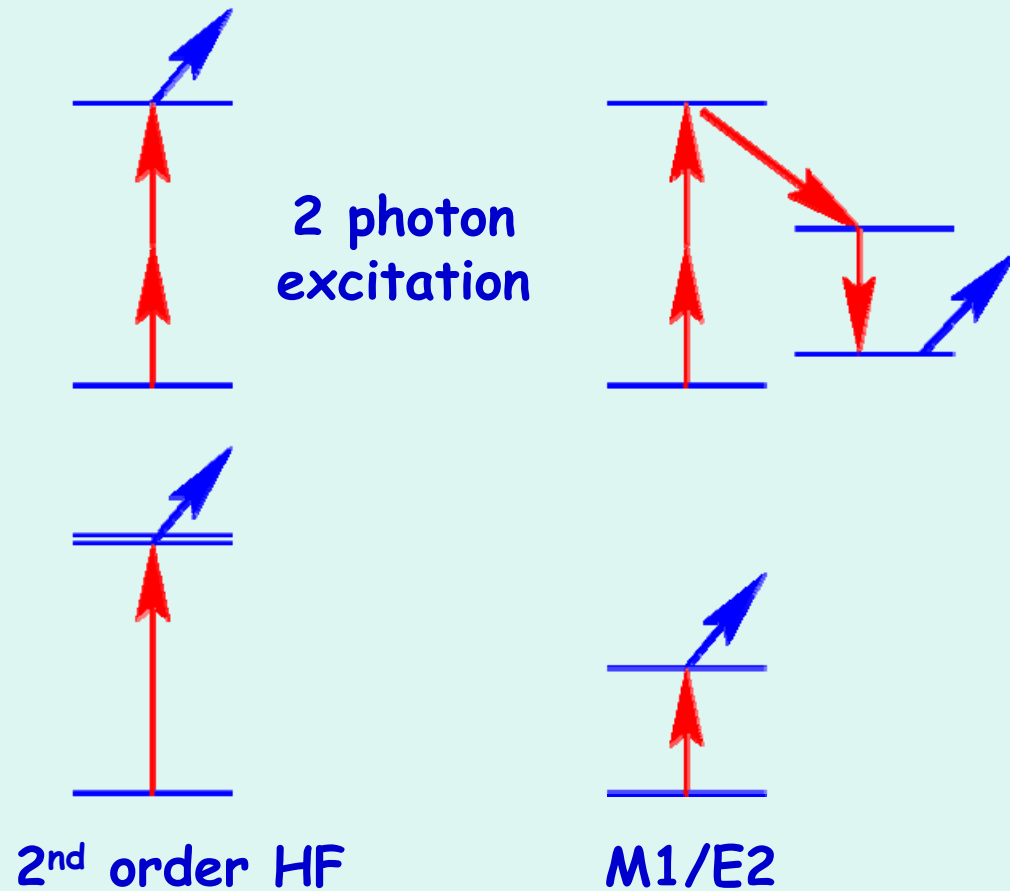
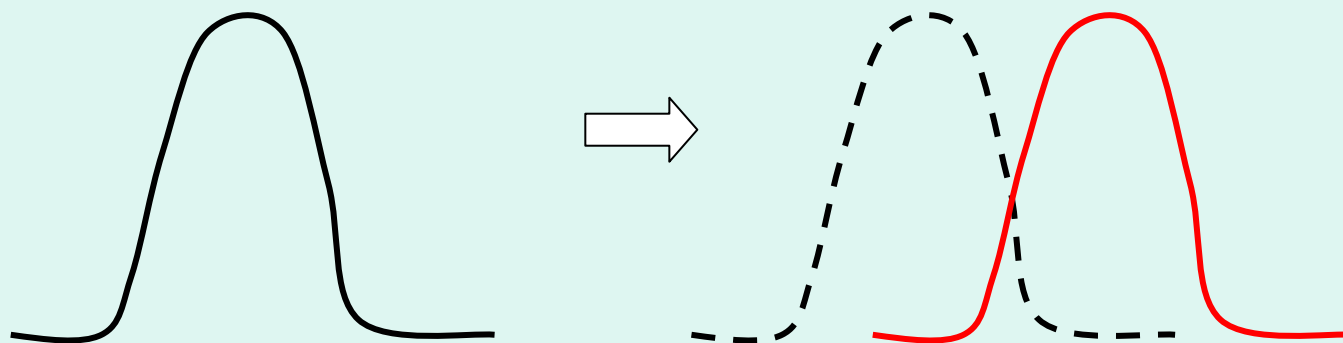
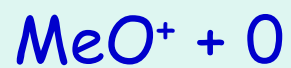
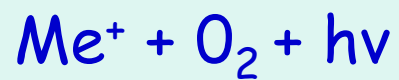
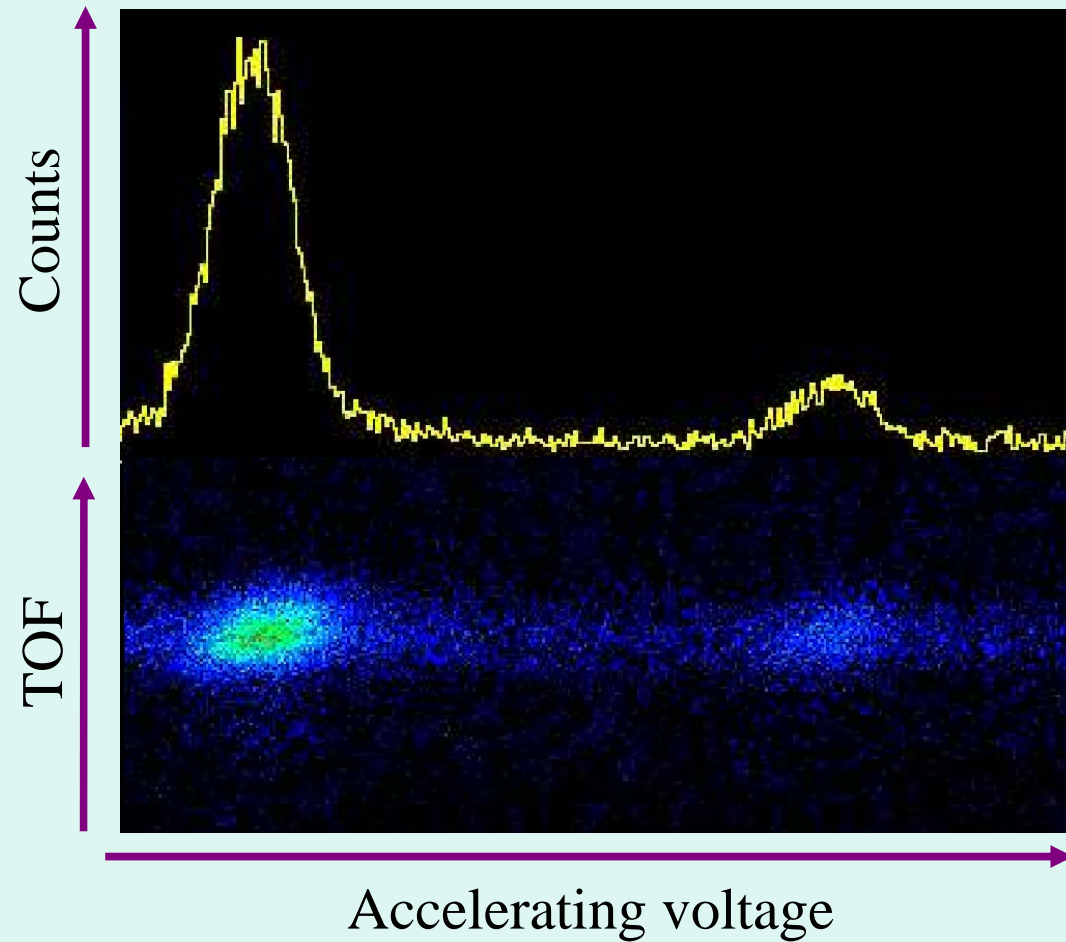

Photo chemistry...



"Step out" of the beam background...



(but see BC's talk!!)

Especially for this:

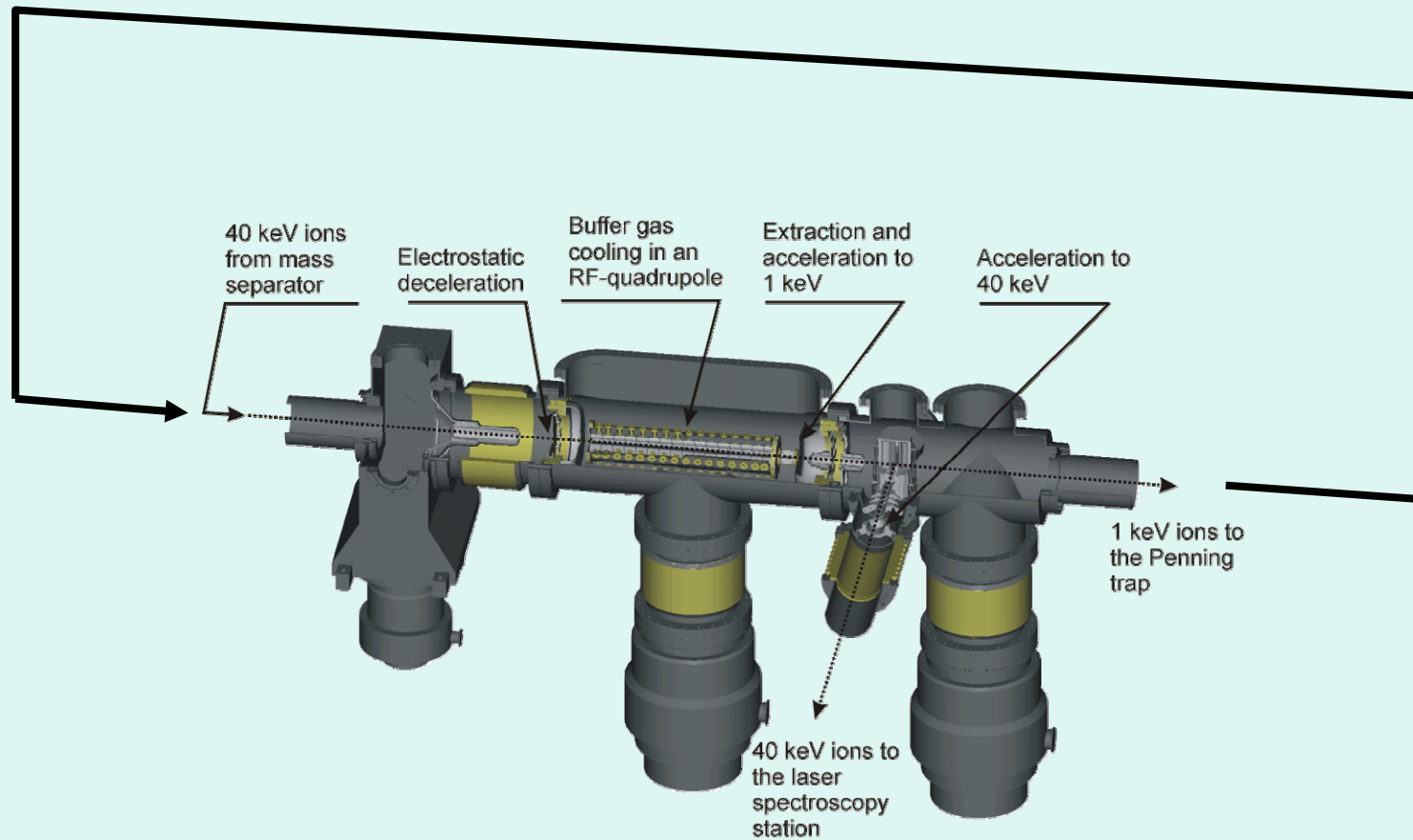

Better still:

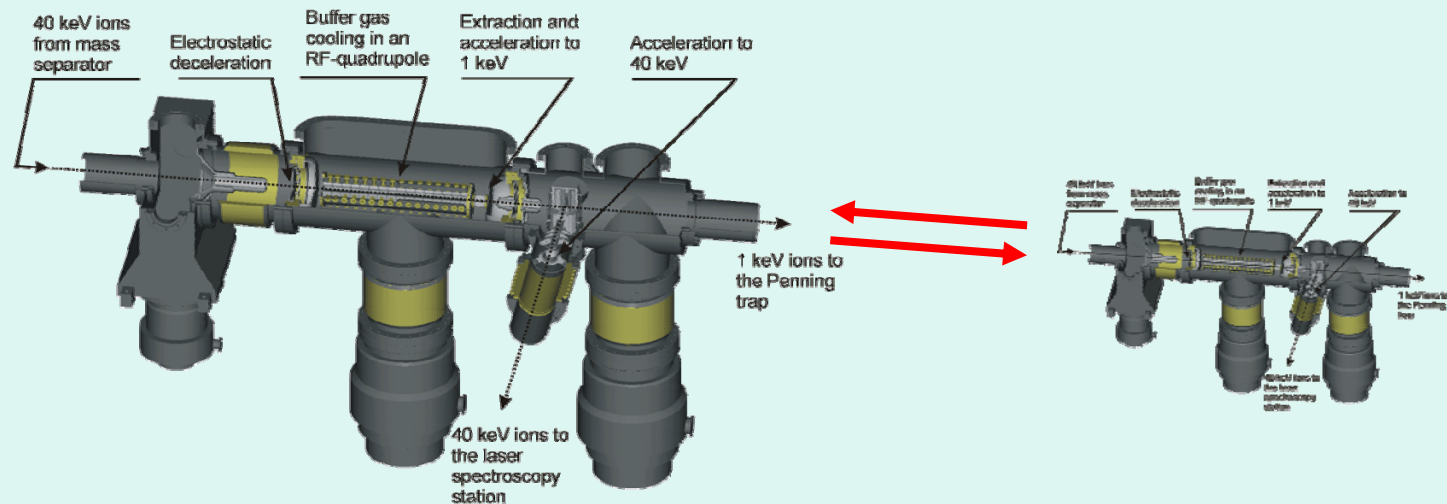

As now..

All manipulations,
voltage changes,
chemicals,
pumping...

Future...

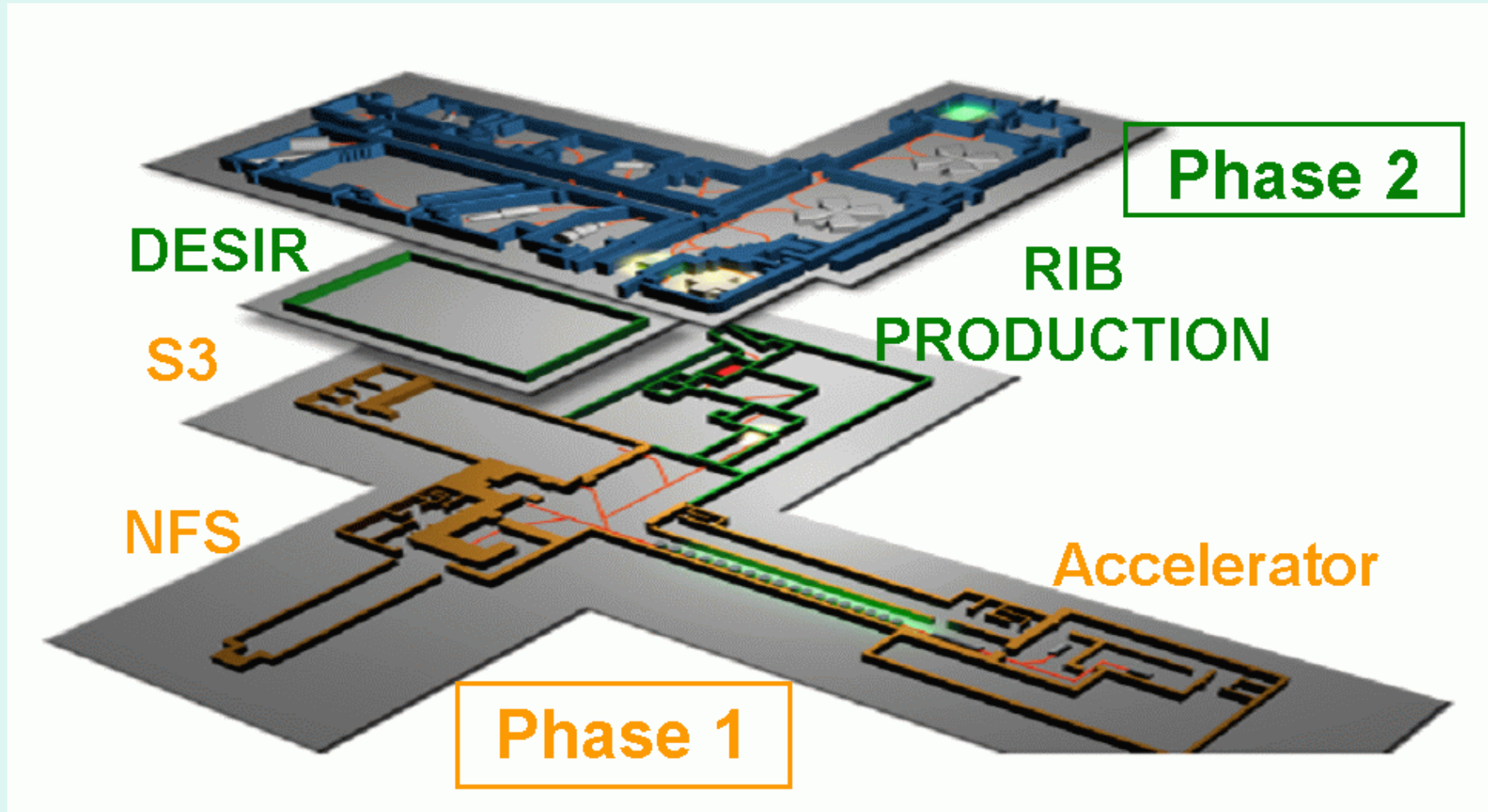

Essential:

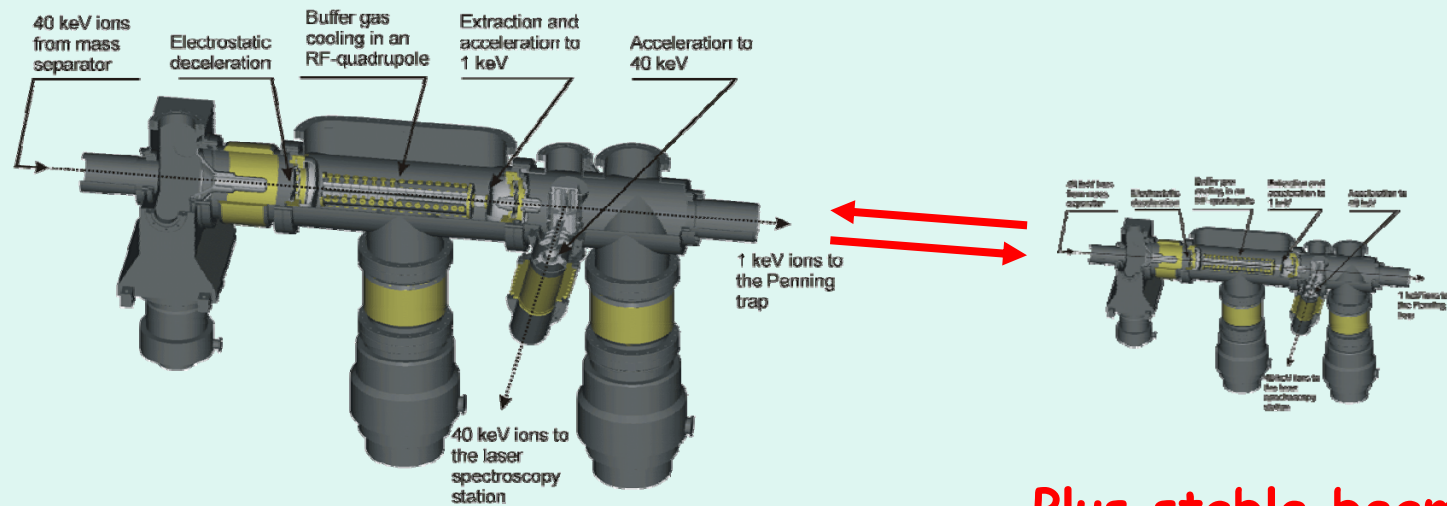

As "usual"...

Plus stable beams
on-line

Photo chemistry...

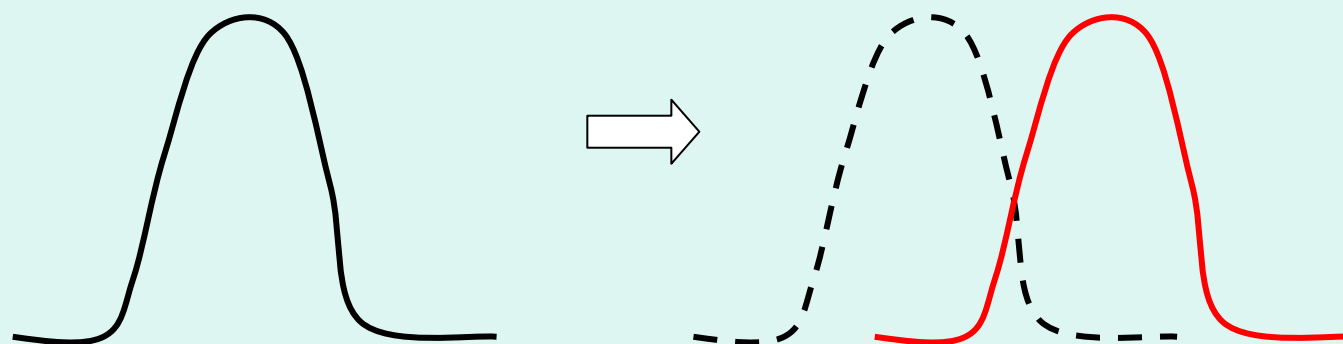
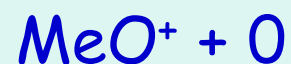
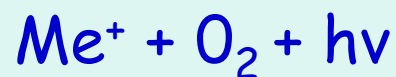

Low resolution...
Ultra-high sensitivity...

c.f. Cu prior to PRL 103, 142501 (2009)

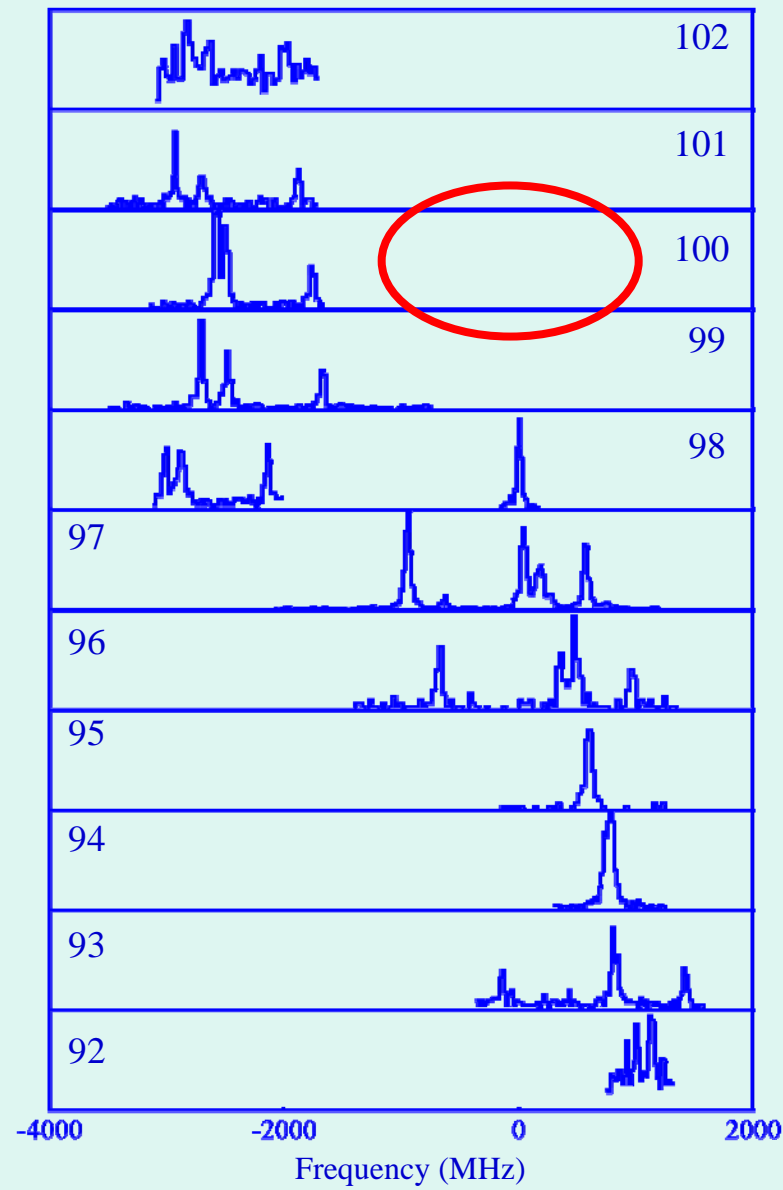

Yttrium at
the limit...

???

we've missed
one...

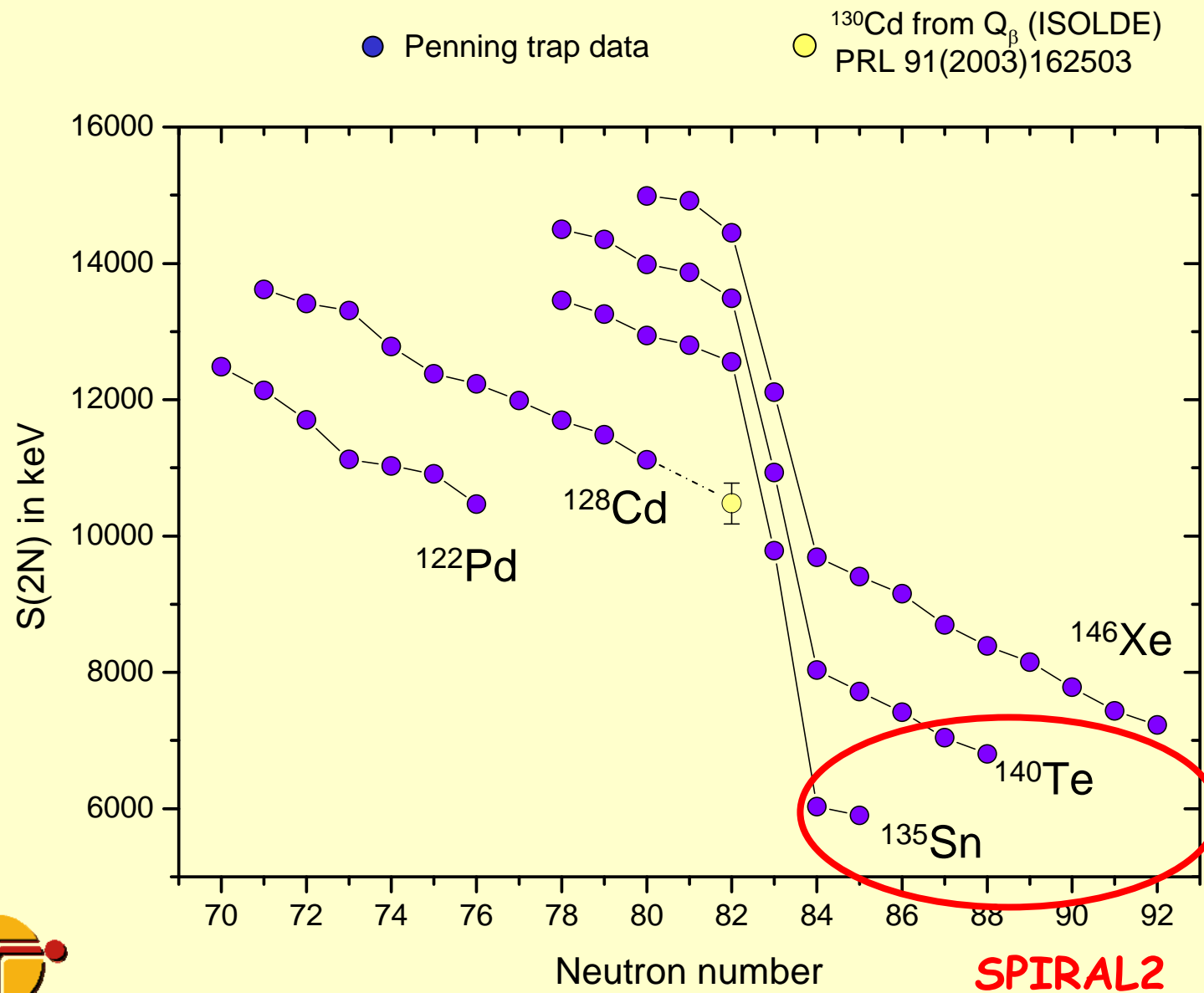

SPIRAL2
hunting for odds

SPIN ASSIGNMENTS...

- Study isotopes on 2 lines
- Polarisation and...
- Measure g simultaneously with moment

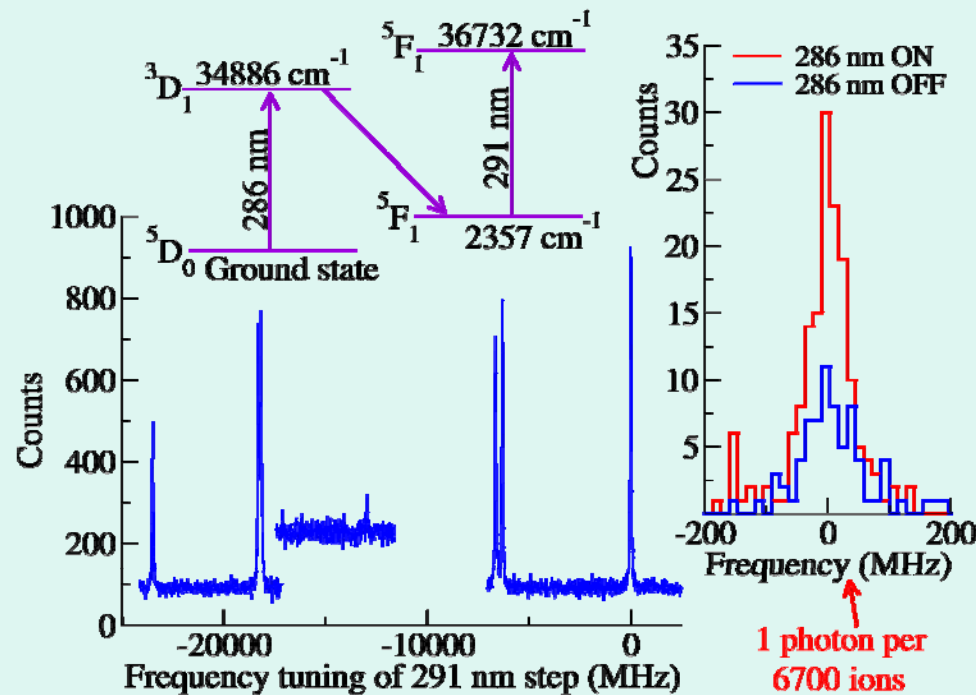
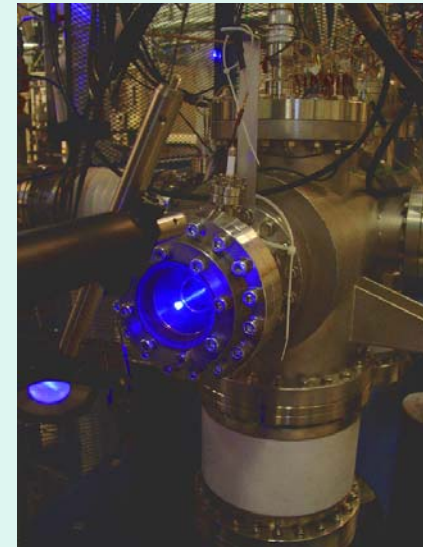

	Ni55 212.1 ms 7/2- EC	Ni56 6.077 d 0+ EC	Ni57 35.60 h 3/2- EC	Ni58 0+ 68.077	Ni59 7.6E+4 y 3/2- EC	Ni60 0+ 26.223	Ni61 3/2- 1.140	Ni62 0+ 3.634	Ni63 100.1 y 1/2- β-	Ni64 0+ 0.926	β
*	Co54 193.23 ms 0+ EC	Co55 17.53 h 7/2- EC	Co56 77.27 d 4+ EC	Co57 271.79 d 7/2- EC	Co58 70.82 d 2+ EC	Co59 7/2- 100	Co60 5.2714 y 5+ β-	Co61 1.650 h 7/2- β-	Co62 1.50 m 2+ β-	Co63 27.4 s (7/2)- β-	β
*	Fe53 8.51 m 7/2- EC	Fe54 0+ 5.8	Fe55 2.73 y 3/2- EC	Fe56 0+ 91.72	Fe57 1/2- 2.2	Fe58 0+ 0.28	Fe59 44.503 d 3/2- β-	Fe60 1.5E+6 y 0+ β-	Fe61 5.98 m 3/2-,5/2- β-	Fe62 68 s 0+ β-	β
	Mn52 5.591 d 6+ EC	Mn53 3.74E+6 y 7/2- EC	Mn54 312.3 d 3+ EC,β-	Mn55 5/2- 100	Mn56 2.5785 h 3+ β-	Mn57 85.4 s 5/2- β-	Mn58 3.0 s 0+ β-	Mn59 46 s 3/2,5/2- β-	Mn60 51 s 0+ β-	Mn61 0.71 s (5/2)- β-	β
y	Cr51 27.702 d 7/2- EC	Cr52 0+ 83.789	Cr53 3/2- 9.501	Cr54 0+ 2.365	Cr55 3.497 m 3/2- β-	Cr56 5.94 m 0+ β-	Cr57 21.1 s 3/2-,5/2-,7/2- β-	Cr58 7.0 s 0+ β-	Cr59 0.74 s β-	Cr60 0.57 s 0+ β-	
	V50 1.4E+17 y 6+ EC,β- 0.250	V51 7/2- 99.750	V52 3.743 m 3+ β-	V53 1.61 m 7/2- β-	V54 49.8 s 3+ β-	V55 6.54 s (7/2)- β-	V56	V57	V58	V59	
	Ti49	Ti50	Ti51 5.76 m	Ti52 1.7 m	Ti53 32.7 s	Ti54	Ti55	Ti56	Ti57	Ti58	

1974

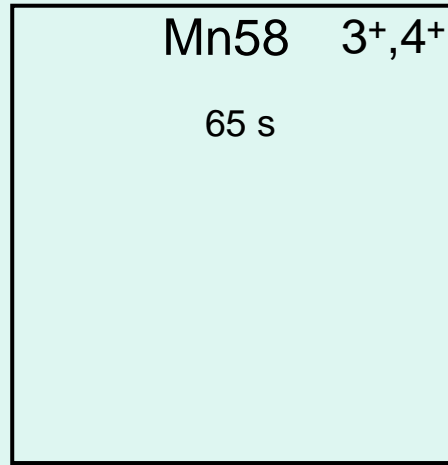

1980

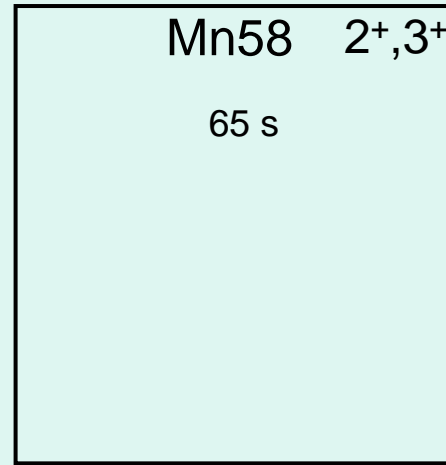

1988

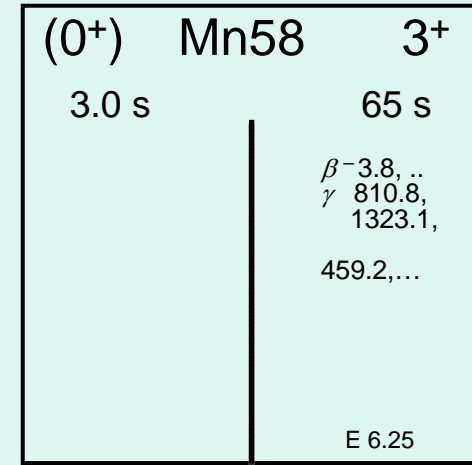

1996

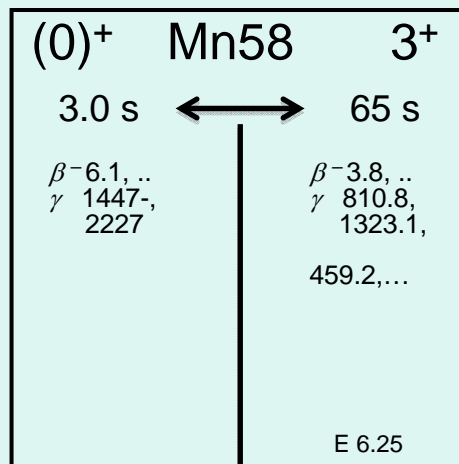

2002

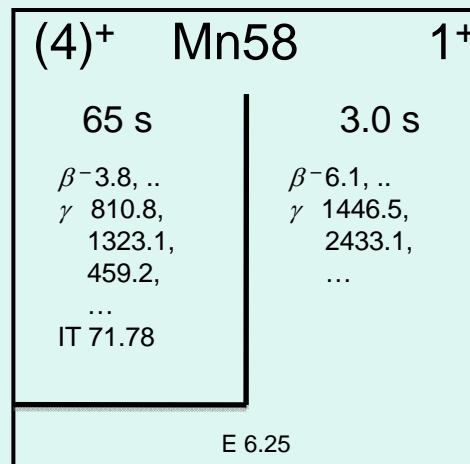

2010

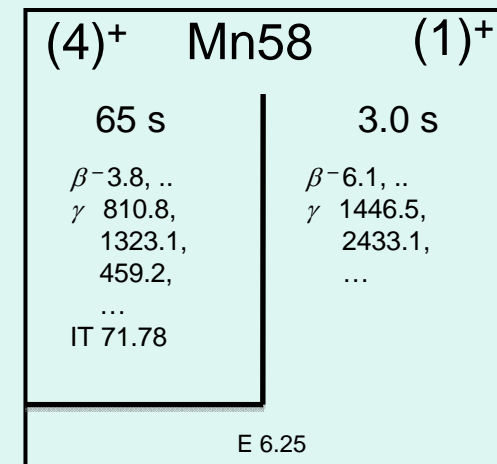

**J Billowes, P Campbell, F Charlwood,
B Cheal, KT Flanagan, D Johnson and T Procter**

(see for S3 cases around Z~28 and IRIS)